

仕様	
機種名	PC-9
定格電圧	100V
定格周波数	50/60Hz
消費電力	550W

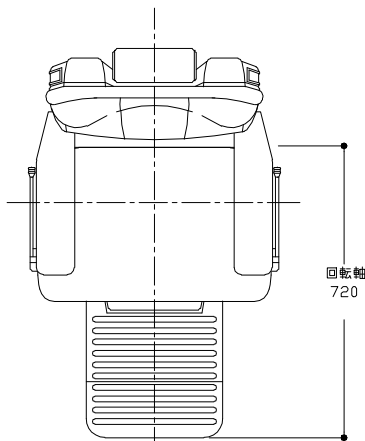
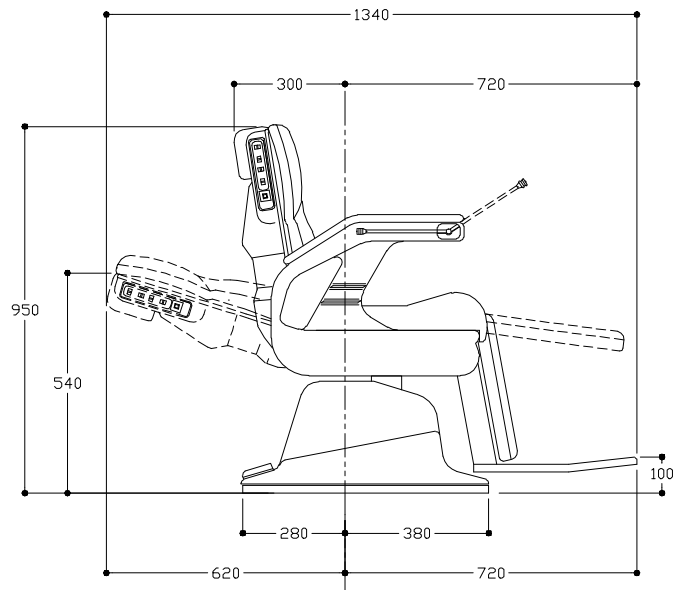
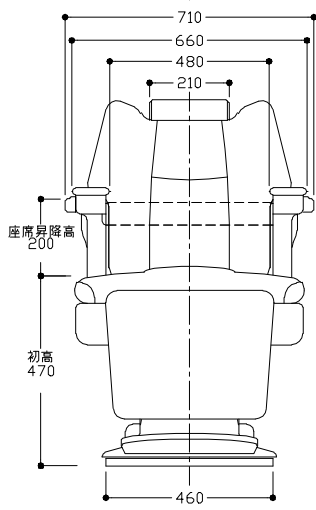

仕様	
機種名	PC-9 スライドベース
定格電圧	100V
定格周波数	50/60Hz
消費電力	550W